

EI47 Laminated transformers 12.0VA Series

Low Frequency, Open-Style Laminated, Split Bobbin, Horizontal Plug-In Series

Features

- ✧ High (2500V) isolation; 2500VRMS HIPOT
- ✧ Non-concentric design - eliminates ESS
- ✧ No crossover between primary/secondary winding leads
- ✧ Vacuum impregnated - withstands board washing systems and reduces audible noise
- ✧ Baked resin provides an environmentally-resistant finish
- ✧ Rugged construction - no additional mounting hardware
- ✧ Universal design, fits industry-standard footprints
- ✧ Available in single or dual primary

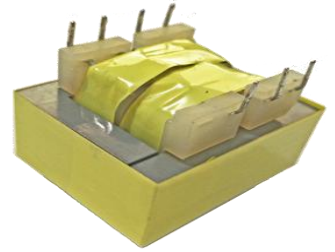

Mechanical:mm

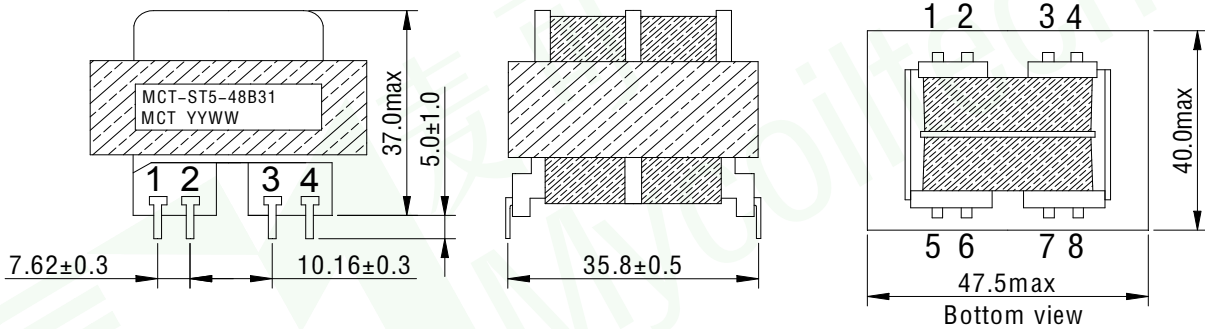

Schematics

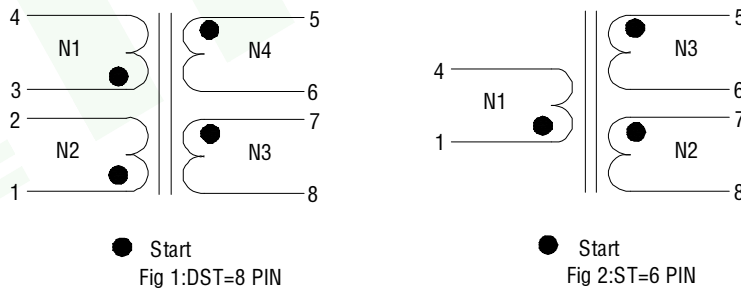

MCT Part No. 115V-6Pin	MCT Part No. 115V/230V-8Pin	Secondary RMS Rating	
		Series	Parallel
MCT-ST5-10B3	MCT-DST5-10B3	10V C.T. @ 1.2A	5V @ 2.4A
MCT-ST5-12B7	MCT-DST5-12B7	12.6V C.T. @ 1.0A	6.3V @ 2.0A
MCT-ST5-16B11	MCT-DST5-16B11	16V C.T. @ 0.8A	8V @ 1.6A
MCT-ST5-20B15	MCT-DST5-20B15	20V C.T. @ 0.6A	10V @ 1.2A
MCT-ST5-24B19	MCT-DST5-24B19	24V C.T. @ 0.5A	12V @ 1.0A
MCT-ST5-28B23	MCT-DST5-28B23	28V C.T. @ 0.42A	14V @ 0.84A
MCT-ST5-36B27	MCT-DST5-36B27	36V C.T. @ 0.35A	18V @ 0.7A
MCT-ST5-48B31	MCT-DST5-48B31	48V C.T. @ 0.25A	24V @ 0.5A
MCT-ST5-56B35	MCT-DST5-56B35	56V C.T. @ 0.22A	28V @ 0.44A
MCT-ST5-120B39	MCT-DST5-120B39	120V C.T. @ 0.1A	60V @ 0.2A