

EI35 Laminated transformers 2.4VA Series

Low Frequency, Open-Style Laminated, Split Bobbin, Horizontal Plug-In Series

Features

- ✧ High (2500V) isolation; 2500VRMS HIPOT
- ✧ Non-concentric design - eliminates ESS
- ✧ No crossover between primary/secondary winding leads
- ✧ Vacuum impregnated - withstands board washing systems and reduces audible noise
- ✧ Baked resin provides an environmentally-resistant finish
- ✧ Rugged construction - no additional mounting hardware
- ✧ Universal design, fits industry-standard footprints
- ✧ Available in single or dual primary

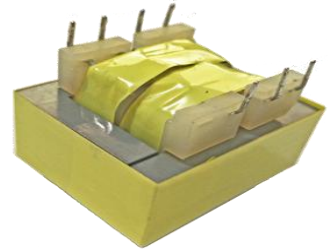

Mechanical:mm

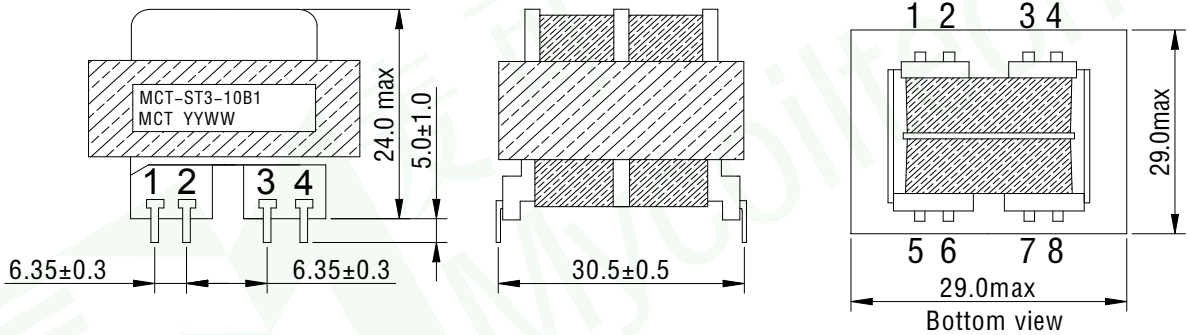

Schematics

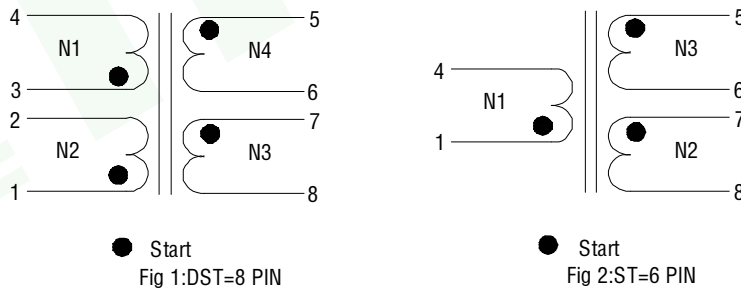

MCT Part No. 115V-6Pin	MCT Part No. 115V/230V-8Pin	Secondary RMS Rating	
		Series	Parallel
MCT-ST3-10B1	MCT-DST3-10B1	10V C.T. @ 0.25A	5V @ 0.5A
MCT-ST3-12B5	MCT-DST3-12B5	12.6V C.T. @ 0.2A	6.3V @ 0.4A
MCT-ST3-16B9	MCT-DST3-16B9	16V C.T.@ 0.15A	8V @ 0.3A
MCT-ST3-20B13	MCT-DST3-20B13	20V C.T. @ 0.12A	10V @ 0.24A
MCT-ST3-24B17	MCT-DST3-24B17	24V C.T. @ 0.1A	12V @ 0.2A
MCT-ST3-28B21	MCT-DST3-28B21	28V C.T. @ 0.085A	14V @ 0.17A
MCT-ST3-36B25	MCT-DST3-36B25	36V C.T. @ 0.065A	18V @ 0.13A
MCT-ST3-48B29	MCT-DST3-48B29	48V C.T. @ 0.05A	24V @ 0.1A
MCT-ST3-56B33	MCT-DST3-56B33	56V C.T. @ 0.045A	28V @ 0.09A
MCT-ST3-120B37	MCT-DST3-120B37	120V C.T. @ 0.02A	60V @ 0.04A